

700XP & 900XP accessories



Thinking of you
Electrolux

Index

Accessories for specific functions	3
Accessories for gas ranges	4
Accessories for electric ranges	6
Accessories for induction ranges	7
Accessories for oven ranges	8
Accessories for fry tops	9
Accessories for grills	11
Accessories for multifunctional cookers	14
Accessories for fryers	15
Accessories for pasta cookers	20
Accessories for bain maries	24
Accessories for braising pans	24
Accessories for boiling pans	27
Accessories for cupboards and open bases	29
Accessories for refrigerated bases	31
Accessories for installation	32
Covering panels	32
Handrails	33
Chimney upstands	34
Junction sealing kit	35
Stainless steel plinths	36
Cover panels for service duct	37
Installation on 100 mm concrete plinth	38
Installation on 150 mm concrete plinth	39
Support for bridge installation	40
Cantilever support	41
Wheels and flanged feet	44
Water columns	45

Accessories for gas ranges

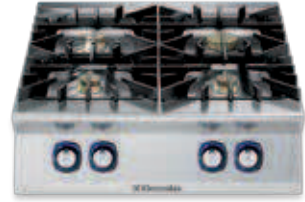

206260



206261

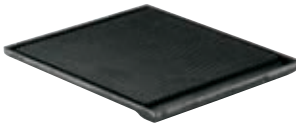

Burner single plates

Range	700XP	
PNC	206260	206261
Plate	smooth	ribbed
Material	cast iron	

- ▶ Fry top mode for gas burners and simple service
- ▶ Use one on the 400 mm models, 2 on the 800 mm models and 3 on the 1200 mm models
- ▶ Can be installed on frontal burners only

921684



921685

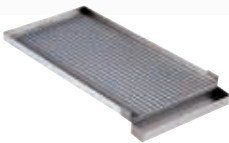

Burner double zone plates

Range	700XP	
PNC	921684	921685
Plate	smooth	ribbed
Material	stainless steel	

- ▶ Fry top mode for 700 range gas burners and simple service
- ▶ Equipped with a removable grease collection container

206264



206170



Burner radiant plates

Range	700XP	900XP
PNC	206264	206170
Notes		only for 6kW burners
Material	cast iron	

- ▶ Solid top mode for gas burners and simple service

Accessories for gas ranges

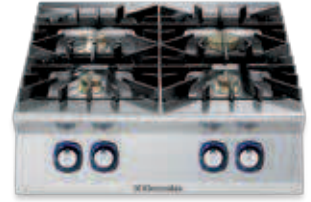

206363



Wok support

Range	700XP and 900XP	
PNC	206363	
Material	stainless steel	

► Wok pan support for open burners

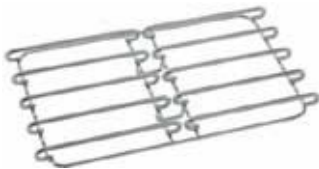
206297
206298

Twin-burner stainless steel grids

Range	700XP	900XP
PNC	206297	206298
Material	stainless steel	

► Pans support for gas burners

206283



Ground support for 3-burner gas boiling top (391024)

Range	900XP
PNC	206283
Material	stainless steel

► Lets the 3-burner top 391024 be used like a stockpot

Accessories for electric ranges



206168
206056



Cast iron bars

Range	700XP	900XP
PNC	206168	206056
Material	cast iron	

- ▶ 2 cast iron bars to obtain 2 wider flat cooking zones
- ▶ 700XP for hot square plates only

Accessories for induction ranges



653596



Induction pans

Range	700XP and 900XP		
PNC	653596	653597	653598
Material	stainless steel	aluminum	aluminum
Handle	stainless steel	stainless steel	stainless steel
Diameter	200 mm	240 mm	280 mm

653597



653598



910613



Induction wok-pans

Range	700XP and 900XP		
PNC	910613	911587	911588
Material	mild steel	stainless steel	stainless steel
Handle	wood	stainless steel	-
Diameter	360 mm	360 mm	360 mm
Height	105 mm	105 mm	-

911587



911588



Accessories for oven ranges



164250



Chrome grid

Range	700XP	900XP
PNC	164250	
Oven	for static oven	
Size	2/1 GN	
Material	chrome	

- ▶ Chrome grid for appliances with gas and electric ovens
- ▶ 1 piece is included in standard delivery

206204

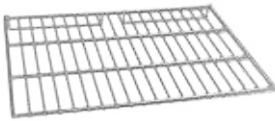

206243

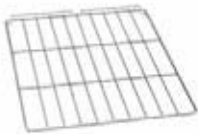

Chrome grids

Range	900XP	
PNC	206204	206243
Oven	for large oven*	for ventilated oven**
Size	972x687 mm	2/1 GN
Material	chrome	

- ▶ * For codes 391015 and 391016; 1 piece is included in standard delivery
- ▶ ** 2 pieces are included in standard delivery

Accessories for fry tops



164255



206420

Scrapers

Range	700XP and 900XP	
PNC	164255	206420
Use on	smooth plate	ribbed plate

- ▶ 1 or 2 pieces, according to the surface type, is included in the standard delivery for the 700XP and 900XP chrome plated models and are optional for mild steel 700XP models

206346



Grease container

Range	700XP and 900XP
PNC	206346

- ▶ Includes containers, guides, stainless steel drain pipe to convey the grease/oil from the fry top cooking surface to the container and front closing panel
- ▶ To be used with top and base

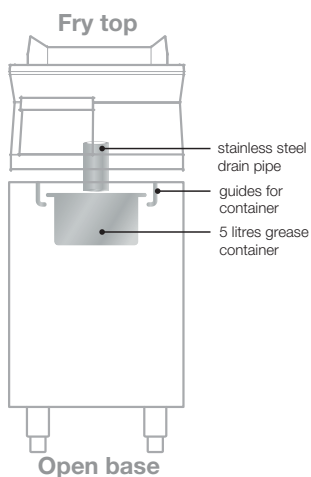

Accessories for fry tops



206296



Stopper

Range	900XP
PNC	206296
Material	stainless steel

- ▶ Stopper for fry top with horizontal plate - used to keep the grease released by the food on the frying plate

206153



216153



206345



Water drains

Range	900XP		
PNC	206153	216153	206345
Appliance width	400 mm	800 mm	1200 mm

Accessories for grills

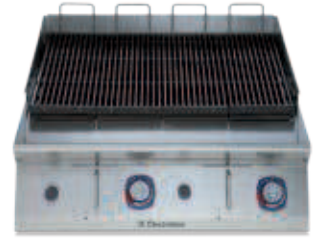

206408

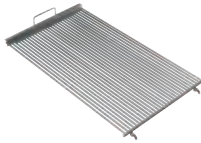

Grids for freestanding gas grills

Range	700XP		900XP	
PNC	206414	206410	206408	206404
Appliance width	400 mm	800 mm	400 mm	800 mm
Material	stainless steel			

- Equipped with cast-iron grids with drainage channels as standard

206415

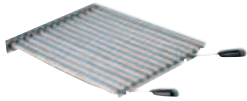

Grids with drain channels for freestanding grills

Range	700XP		900XP	
PNC	206415	206411	206409	206405
Appliance width	400 mm	800 mm	400 mm	800 mm
Material	stainless steel			

- Equipped with cast-iron grids with drainage channels as standard

206418

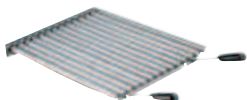

Grids with drain channels for top grills

Range	700XP	
PNC	206418	206416
Appliance width	400 mm	800 mm
Material	stainless steel	

- Equipped with cast-iron grids with drainage channels as standard

Accessories for grills

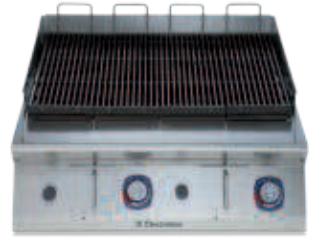

206422



Scrapers

Range	700XP and 900XP	
PNC	206421	206422
Material	stainless steel with drain channels	cast iron

- For cast iron grids with drainage channels it is included in standard delivery

Accessories for grills



206280



Water filling taps

Range	700XP and 900XP	
PNC	206280	206281
Appliance width	400 mm	800 mm

► For gas and electric freestanding grills

Accessories for multifunctional cookers



921689



Lids

Range	700XP and 900XP	
PNC	921689	921690
Appliance width	400 mm	800 mm

921690



► For gas and electric multifunctional cookers

164255



Scrapers

Range	700XP and 900XP	
PNC	164255	921694
Note	scraper	blades with rounded corners

921694



► Included in standard delivery

Accessories for fryers

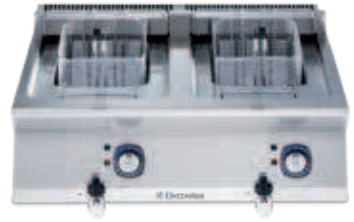

960638



921608



Baskets for gas and electric fryers

Range	700XP	
PNC	960638	921608
Quantity	2	1
Size	half	full
Appliance typology	2x5 and 7 lt electric	7 lt

► 960638 is included in standard delivery

921629



921691



921692



Baskets for gas and electric fryers

Range	700XP		
PNC	921629	921691	921692
Quantity	1	1	2
Size	full	full	half
Appliance typology	12 lt electric (top)	14 and 15 lt	12 lt (freestanding), 14 and 15 lt

► 921629 is included in standard delivery

921609



921642



Baskets for gas and electric fryers

Range	700XP	
PNC	921609	921642
Quantity	1	1
Size	half	full
Appliance typology	34 lt	34 lt

► 921609 is included in standard delivery

Accessories for fryers

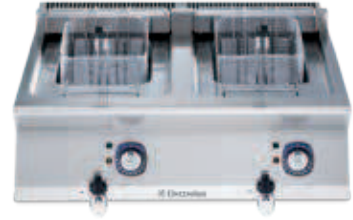

206316



206196



Baskets for electric programmable fryer

Range	700XP	
PNC	206316	206196
Quantity	2	1
Size	half	full

921691



921692



Baskets for gas and electric fryers

Range	900XP	
PNC	921691	921692
Quantity	1	2
Size	full	half
Appliance typology	14 and 15 lt	14 and 15 lt

► 921691 is included in standard delivery

927223



927226



Baskets for gas and electric fryers

Range	900XP	
PNC	927223	927226
Quantity	2	1
Size	half	full
Appliance typology	18 and 23 lt	18 and 23 lt

► 927223 is included in standard delivery

Accessories for fryers

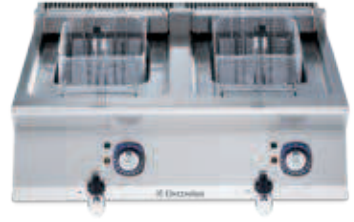

206235



206173

Sediment trays

Range	700XP and 900XP	
PNC	206235	206173
Appliance typology	15 lt	23 lt

► For freestanding V-shape fryers

921695



927227



Unclogging rods

Range	700XP and 900XP	
PNC	921695	927227
Appliance typology	15 lt	23 lt

► For drain pipe of freestanding V-shape fryers

921693



Oil filter for freestanding fryers

Range	700XP
PNC	921693
Appliance typology	7, 2x7, 14, 2x14, 15 and 2x15 lt
Material	stainless steel

Accessories for fryers

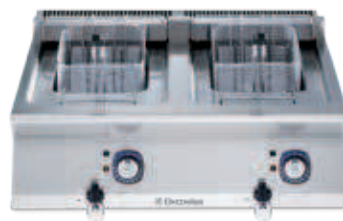

206359

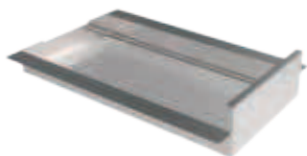

Filter for free-standing fryers

Range	900XP
PNC	206359
Appliance typology	freestanding
Material	stainless steel

206209

206301

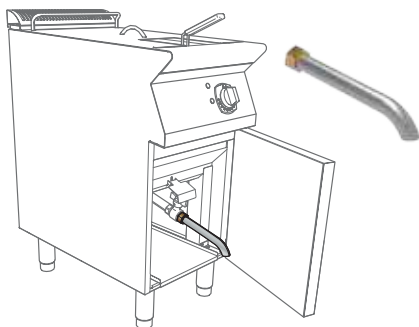

Extension for oil drainage

Range	700XP and 900XP	
PNC	206209	206301
Appliance typology	23 lt	15 lt freestanding electric

► Compulsory when the fryer is installed on plinth

921696



960645



Deflectors

Range	700XP and 900XP	900XP
PNC	921696	960645
Appliance typology	15 lt	23 lt

- For floured products for freestanding V-shape fryers
- The deflector is lying on the inclined part of the well, in order to avoid the bread or flour released by the products to lie there and get burned.

Accessories for fryers



206201



Small opening hygienic lid for fryers

Range	900XP
PNC	206201
Appliance typology	23 lt

► Standard lid delivered as standard for the 23 litres fryer model.

Accessories for pasta cookers



921611



Baskets

Range	700XP	
PNC	921611	921610
Quantity	1	2
Size	350x200 mm	170x220 mm
Appliance typology	24.5 and 24.5+24.5 lt	24.5 and 24.5+24.5 lt

921610



► Baskets are not included as standard; only exception is programmable pasta cooker with automatic lifting (code 371100)

921619



Baskets

Range	700XP	
PNC	921619	
Quantity	2	
Size	105x350 mm	
Appliance typology	24.5 and 24.5+24.5 lt	

► Baskets are not included as standard; only exception is programmable pasta cooker with automatic lifting (code 371100)

921618



Baskets and support for baskets

Range	700XP	
PNC	921618	921606
Quantity	4	1
Size	105x160 mm	230x350 mm
Appliance typology	24.5 and 24.5+24.5 lt	24.5 and 24.5+24.5 lt
Note	baskets	support

921606



► Baskets are not included as standard; only exception is programmable pasta cooker with automatic lifting (code 371100)

Accessories for automatic pasta cookers



206312



206314



Baskets for automatic pasta cooker

Range	700XP	
PNC	206312	206314
Quantity	2	2
Size	115x163 mm	105x350 mm
Appliance typology	automatic pasta cooker	

Accessories for pasta cookers



206236



206237



Baskets

Range	900XP	
PNC	206236	206237
Quantity	1	1
Size	130x130 mm 6 fit in a 40 lt well	135x310 mm 2 fit in a 40 lt well
Appliance typology	40 and 40+40 lt	40 lt

206233



206238



Baskets and support for baskets

Range	900XP	
PNC	206233	206238*
Quantity	1+2	1
Size	1x 1/3 GN + 2x135x310 mm	295x505 mm
Appliance typology	40 and 40+40 lt	40 and 40+40 lt
Note	baskets	support

► Code 206238 compulsory for: 206236, 206237, 206233

927216



927211



927210



Baskets

Range	900XP		
PNC	927216	927211	927210
Quantity	1	2	3
Size	1/1 GN	1/2 GN	1/3 GN
Appliance typology	40lt	40lt	40lt

Accessories for pasta cookers



927212



Round baskets

Range	900XP	
PNC	927212	927213
Quantity	3	6
Size	Ø 181 mm	Ø 135 mm
Appliance typology	40 lt	40 lt

927213



927219



Supports for 40 lt pasta cookers

Range	900XP	
PNC	927219	960644
Size	290x500x115 mm	330x535x10 mm
Note	grid support for round baskets (compulsory for 927212 and 927213)	support frame to hold 6 round baskets (alternative to 927219)

960644



Accessories for pasta cookers



921607

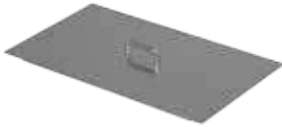

206190

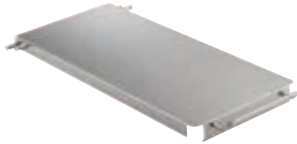

Lids and lid holder

Range	700XP	900XP
PNC	921607	206190
Appliance typology	24.5 lt	40 lt
Note	lid	lid and lid holder

206344



Energy Saving Device

Range	700XP and 900XP
PNC	206344
Note	1 per well needed

► Used to preheat fresh water to refill the well, thus saving energy

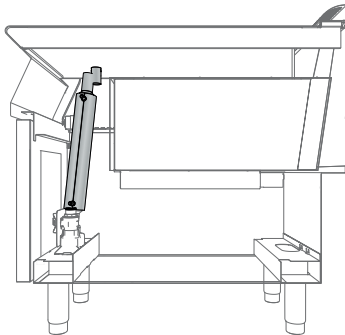

Accessories for pasta cookers



206352

2 Lifting arms

Push-buttons for
manual use or
cooking cycle start

User interface
(9 programs storable)

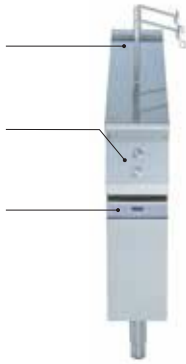

Programmable basket lifting unit

Range	700XP
PNC	206352
Dimension	200 mm wide

Available baskets



921610 - 2 baskets 170x220 mm
see page 20



921618 - 4 baskets 105x160 mm
see page 20

206353

3 Lifting arms

Push-buttons for
manual use or
cooking cycle start

User interface
(9 programs storable)

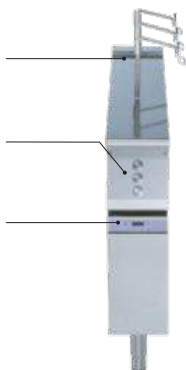

Programmable basket lifting unit

Range	900XP
PNC	206353
Dimension	200 mm wide

Available baskets



927210 - 3 X 1/3GN baskets
see page 22



206236 - 1 basket 130x130 mm
see page 22

Accessories for bain maries



921622



Drilled false bottoms

Range	700XP and 900XP	
PNC	921622	921623
Appliance width	400 mm	800 mm

Accessories for braising pans



922403



Trolleys with lifting and removable tank

Range	700XP and 900XP	
PNC	922403	
Material	stainless steel	

Accessories for boiling pans



921626



Basket

Range	700XP and 900XP
PNC	921626
Appliance typology	60 lt
Note	1-section basket

► To make your boiling pan work as a pasta cooker!

925093



Basket

Range	900XP
PNC	925093
Appliance typology	100 lt
Note	2-section basket

► To make your boiling pan work as a pasta cooker!

206123



Basket

Range	900XP
PNC	206123
Appliance typology	150 lt
Note	2-section basket

► To make your boiling pan work as a pasta cooker!

Accessories for boiling pans



206279



Automatic depressurization kit

Range	700XP and 900XP
PNC	206279
Appliance typology	100 and 150 lt

- ▶ For indirect heating boiling pans (double jacketed)
- ▶ If not installed: depressurization of the double-jacket must be done manually

927222



Water additive against corrosion

Range	700XP and 900XP
PNC	927222
Appliance typology	100 and 150 lt indirect heating

- ▶ For indirect heating boiling pans
- ▶ 1 container of water additive against corrosion is already included in the standard appliances delivery

Accessories for cupboards and open bases



206350



Door for open base

Range	700XP and 900XP
PNC	206350

- ▶ Same for left and right-side door

206259



Electric heating kit for cupboard

Range	700XP and 900XP
PNC	206259
Electric conn.	230V 1ph 50/60 Hz
Power	0.65 kW

- ▶ To be fixed on the bottom of the base
- ▶ The base has to be with doors and can not be used as holding cabinet for food

206245



Central support

Range	700XP and 900XP
PNC	206245
Note	central support for installation of drawers and grids (on 800/1200 mm bases) and of doors (on 1200 mm bases)

- ▶ Needed for installation of drawers and grid runners (1 piece for 800 mm)
- ▶ Needed for installation of drawers and grid runners (2 pieces for 1200 mm) or only doors (1 piece for 1200 mm)
- ▶ Needed if Powergrill or HP fry top are mounted on base

Accessories for cupboard and open bases

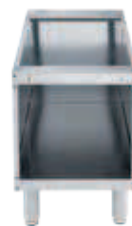

206244



Supports with side runners

Range	700XP		900XP
PNC	206257	206244	206145
Note	2 supports with side runners for 4 GN 1/1 containers for open base 371112, 371113 and 371114	2 supports with side runners for 4 GN 1/1 containers for cupboards	2 supports with side runners for 4 GN 1/1 containers for open base or cupboards

206318



Drawers

Range	700XP	900XP
PNC	206318	206334
Quantity	2	2
Height	100 mm	100 mm

Accessories for refrigerated bases



206351



Drawers

Range	700XP
PNC	206351
Quantity	2

Installation accessories

Covering panels

216000
216134



216277
216278



Aesthetical side covering panels

Range	700XP	900XP
PNC	216000	216134
Appliance typology	freestanding 700 mm high	freestanding 700 mm high
PNC	216277	216278
Appliance typology	top 250 mm high	top 250 mm high

► The code includes 2 side covering panels

206373



Rear covering panels

Range	700XP and 900XP			
PNC	206373	206374	206375	206376
Size	600 mm	800 mm	1000 mm	1200 mm

► For island installation to cover the back of the appliances

Installation accessories

Handrails

216047



Front handrails 50 mm depth

Range	700XP and 900XP			
PNC	216046	216047	216049	216050
Size	400 mm	800 mm	1200 mm	1600 mm

206307



Side handrails 50 mm depth

Range	700XP	900XP
PNC	206307	216044
Note	2 pieces: right and left side	2 pieces: right and left side

216185



Portioning shelves 140 mm depth

Range	700XP and 900XP	
PNC	216185	216186
Size	400 mm	800 mm

Installation accessories

Chimney upstands

206304



Chimney upstands

Range	700XP and 900XP				
PNC	206302	206303	206304	206305	206306
Width	200 mm	400 mm	800 mm	1000 mm	1200 mm

206400



Chimney grid nets

Range	700XP and 900XP			
PNC	206399	206400	206402	206403
Width	200 mm	400 mm	500 mm	590 mm

Installation accessories

Junction sealing kit

206086



Junction sealing kit

Range	700XP and 900XP
PNC	206086
Note	junction sealing kit to fill any possible gap between side-by-side appliances and prevent from any dirt infiltration

Installation accessories

stainless steel plinths



Frontal kicking strips

Range	700XP and 900XP					
PNC	206174	206175	206176	206177	206178	206179
Width	200 mm	400 mm	800 mm	1000 mm	1200 mm	1600 mm
Appliance typology	all*	all*	all*	all*	all*	all*

► * Except 23 lt fryer and ref-freezer base

Frontal kicking strips

Range	900XP	
PNC	206203	880336
Appliance typology	23 lt fryers	ref-freezer base

Side kicking strips

Range	700XP	900XP	900XP
PNC	206249	206180	880221
Width	700 mm	900 mm	900 mm
Appliance typology	all*	all*	ref-freezer base

► * Except ref-freezer base

Kicking strips final effect



► Front and side kicking strips are aesthetical and hygienic elements, but they do not support the appliance's weight (that is the feet's task)

Cover panels for Service duct

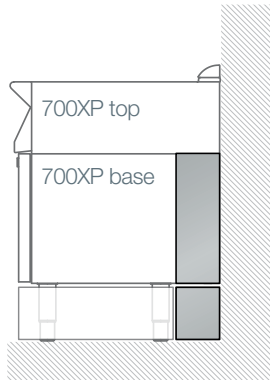

Kit of panels for service duct

Range	700XP
PNC	206248
Note	kit of panels for service duct for installation top on base*
Size	300x40x160 mm

- ▶ Freestanding versions of 700XP are without service duct
- ▶ Service duct cover panels are not needed in case aesthetical cover panels (code 216000) are ordered

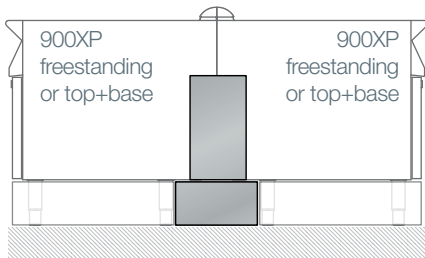

Kit of panels for service duct

Range	900XP
PNC	206202
Note	kit of panels for service duct for back to back installation
Size	900x20x150 mm

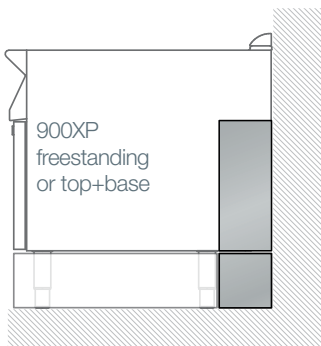

Kit of panels for service duct

Range	900XP
PNC	206181
Note	kit of panels for service duct for installation top on base or for freestanding units
Size	300x40x160 mm

- ▶ Service duct cover panels are not needed in case aesthetical cover panels (code 216134) are ordered

Installation on 100 mm concrete plinth

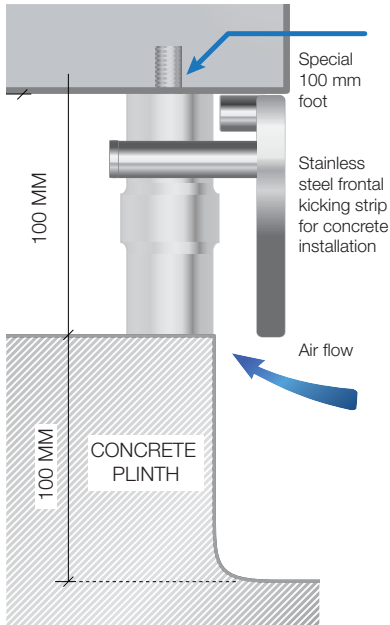

Special feet for concrete installation

Range	700XP and 900XP
PNC	206210
Appliance typology	all*

- ▶ *Except ref-freezer base
- ▶ 1 kit per appliance
- ▶ Ref-freezer base (code 727096) cannot be installed on plinth
- ▶ The concrete plinth must be 100 mm high in order to have the worktop at 900 mm height: special feet for concrete installation are not adjustable in height

Frontal kicking strips

Range	700XP and 900XP					
PNC	206146	206147	206148	206150	206151	206152
Width	200 mm	400 mm	800 mm	1000 mm	1200 mm	1600 mm



Side kicking strips

Range	700XP	900XP
PNC	206265	206157

Installation on **150 mm concrete plinth**

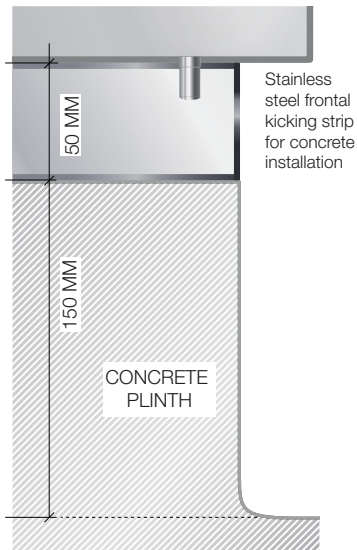

Accessories for installation on 150 mm high concrete plinth are available on request.

- ▶ Special frame for installation
- ▶ Available for all appliances except for ref-freezer base (code 727096) and some limitations for freestanding fryers due to the oil collection basin which cannot be installed

Support for bridge installation

206137



Supports for bridge installation

Range	700XP and 900XP					
PNC	206154	206137	206138	206139	206140	206141
Width	400 mm	800 mm	1000 mm	1200 mm	1400 mm	1600 mm

► Only for top appliances

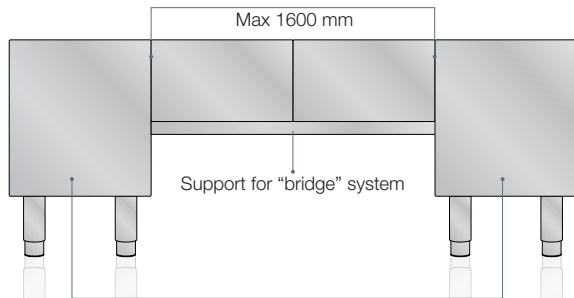

400/800 mm freestanding appliances
(it is recommended to use flanged feet
for 400 mm appliances)

Installation accessories

Cantilever support

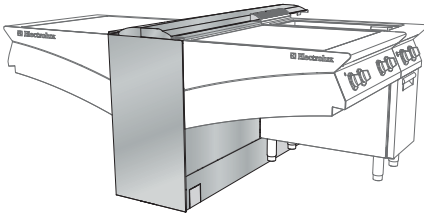

Central supports with service duct

Range	700XP and 900XP				
PNC	206216	206217	206218	206219	206220
Size	2000 mm	2400 mm	2800 mm	3200 mm	3600 mm

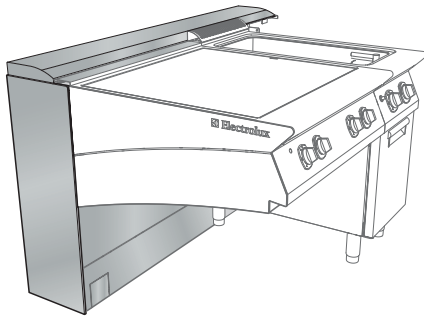

Wall type supports with service duct

Range	700XP and 900XP				
PNC	206211	206212	206213	206214	206215
Size	2000 mm	2400 mm	2800 mm	3200 mm	3600 mm

- ▶ Special frame for installation
- ▶ Includes support frame, cover panels of central column, lower frontal cover panels of the support frame, top cover panel

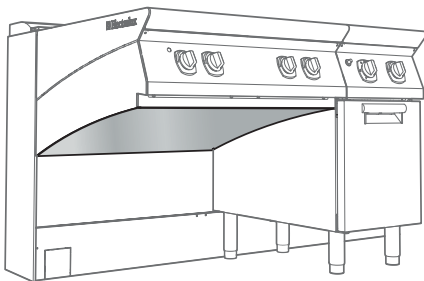

Undercover panels

Range	700XP			
PNC	206323	206324	206325	206329
Size	200 mm	400 mm	800 mm	1200 mm

Range	900XP			
PNC	206330	206331	206332	206336
Size	200 mm	400 mm	800 mm	1200 mm

Installation accessories

Cantilever support bars and cover panels

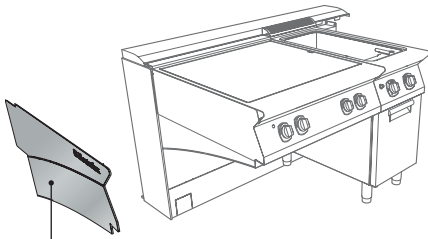

Cover panel.

No need to order lower covering elements in this case
(codes 206258, 206295)

2 aesthetic side cover panels

Range	700XP	900XP
PNC	206326	206337

► Ask your local Electrolux Sales representative for the Cantilever Configurator

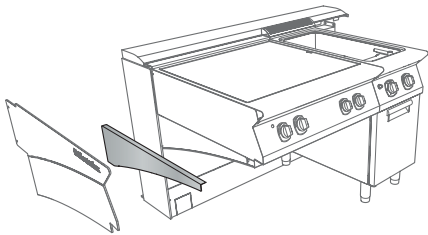

2 lower covering elements

Range	700XP	900XP
PNC	206258	206295

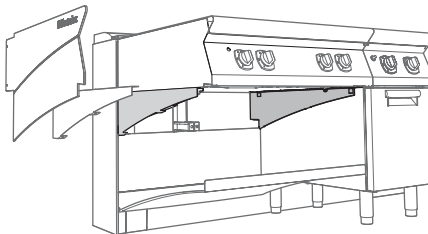

2 support bars for top units

Range	700XP	900XP
PNC	206315	206322

Installation accessories

Cantilever support

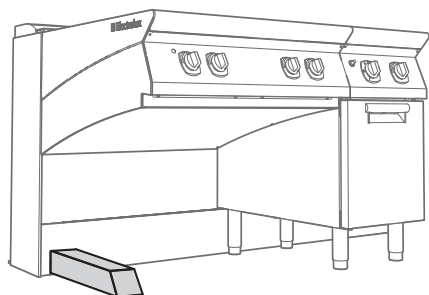

Floor fixing foot

Range	700XP and 900XP
PNC	206226

Installation accessories

Wheels and flanged feet

206135



Wheels

Range	700XP and 900XP	
PNC	206135	880123
Appliance	4 wheels (2 with brakes)	4 wheels for ref-freezer base



Supports for hygienic installation on feet or wheels - cross-wise

Range	700XP and 900XP				
PNC	206366	206367	206368	206369	206370
Appliance typology	all*	all*	all*	all*	all*
Width	400 mm	800 mm	1200 mm	1600 mm	2000 mm

- ▶ *Except 6 burner range with large oven and 900XP fryers
- ▶ Not for top appliances
- ▶ Can be used for installation on feet or on wheels

Supports for hygienic installation on feet or wheels - length-wise

Range	700XP and 900XP	
PNC	206371	206372
Appliance typology	6 burner range with large oven 700XP or pastacookers	23 lt fryers

- ▶ Not for top appliances
- ▶ Can be used for installation on feet or on wheels
- ▶ Refrigerated base 700XP and 900XP can be installed on request

206136



Flanged feet

Range	700XP and 900XP	
PNC	206136	
Quantity	2	

Installation accessories

Water columns

206377



Flow meter

Range	700XP	900XP
PNC	206377	206378

- ▶ Top equipped with water column and liter counter

206289



Water column with swivel arm

Range	700XP and 900XP
PNC	206289

- ▶ Cannot be installed on: Fryers, Chip scuttles, Bases (neutral, freezer, refrigerated)

206290



Water column extension

Range	700XP and 900XP
PNC	206290

- ▶ Not needed when the water column inlet can be reached directly with the flexible water hose from the water net

Installation accessories

Water columns

206231



External support for water column

Range	700XP and 900XP
PNC	206231

- ▶ To install the water column on the side or rear of the appliance

Request an offer to personalize your cooking area

Name E-mail
..... Telephone
Company Fax
.....
Address
.....

Item name	PNC	Quantity

Dealer stamp



Look for the Electrolux partner nearest to you in our website:
www.electrolux.com/professional

Excellence with the environment in mind

Electrolux Professional solutions perfectly match the customers' needs, including the areas of reliability, cost efficiency and sustainability. The products are the best in terms of quality – durability with low running costs. Some installations have been running for more than 40 years!

- All Electrolux Professional factories are ISO 14001-certified
- All Electrolux Professional solutions are designed for low water, energy and detergent consumption, and for low emissions into the environment
- All Electrolux Professional solutions are the best-in-class in terms of quality, for a long life cycle with the lowest life cycle costs. There are solutions still running after 40 years
- All Electrolux Professional solutions are ROHS and REACH-compliant and over 95% recyclable
- All Electrolux Professional solutions are 100% quality tested and all of the functions are singularly checked by expert technicians
- In the last five years, more than 70% of Electrolux Professional solutions have been updated with features that are always designed with the needs of customers and environmental considerations in mind
- Electrolux Professional sustains a specific energy saving program to reduce the energy consumption of its production plants



Thinking of you
Electrolux